

Accessories

Series for Safety switches SLC

Description **ESCR-20-1**

Article number **6051201007**

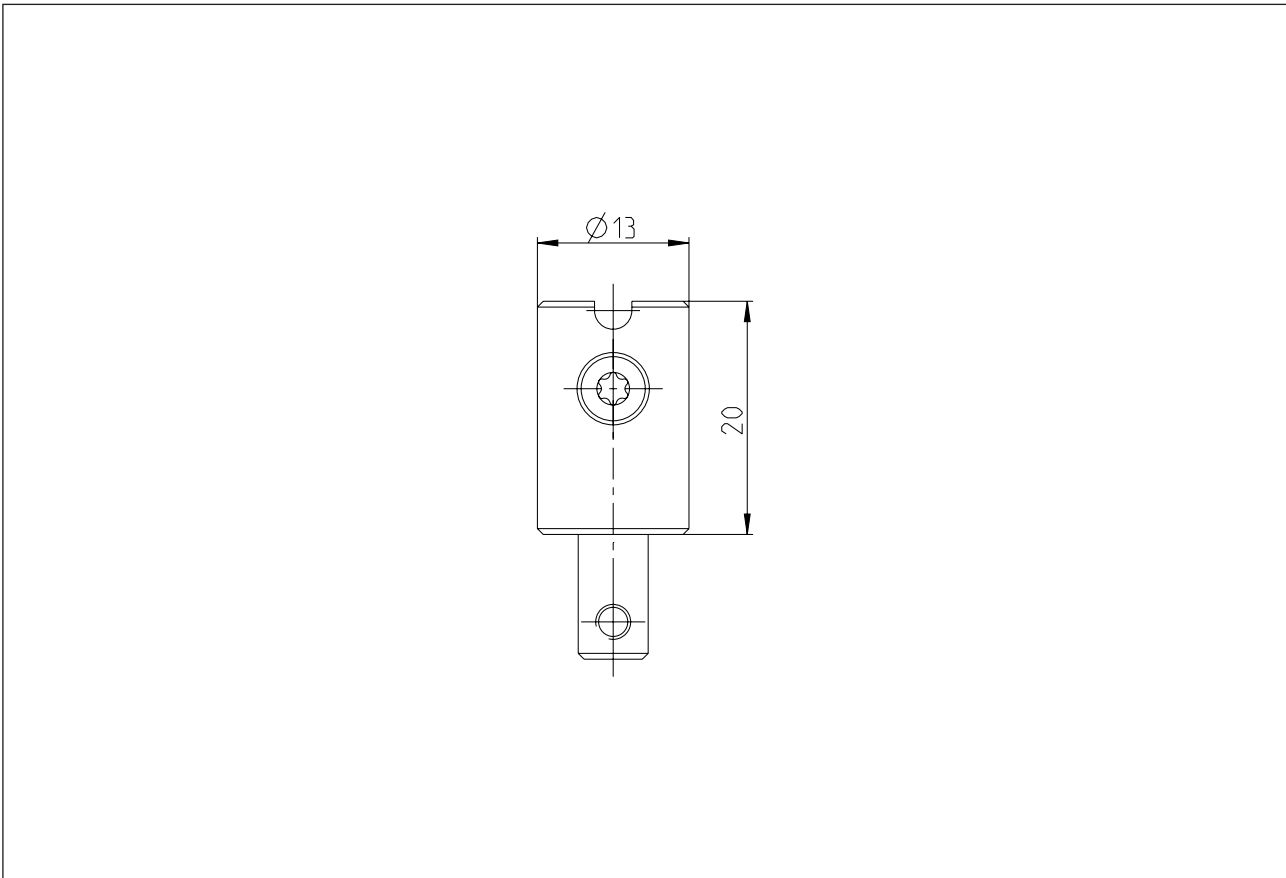

Mechanical data

Material Aluminium

Notes

This component is only to be used in conjunction with ESCR-B-X.